

Fiche technique du produit

Spécifications



Harmony XB4 - tête bouton tournant à clé 421E - Ø22 - 2 pos fix - retr G

ZB4BG212

Statut commercial: Commercialisé

Principales

Gamme de produit	Harmony XB4
Type de produit ou équipement	Tête d'interrupteur à clé
Nom de l'appareil	ZB4
Matériau de la collerette	Métal chromé
Diamètre de fixation	22 mm
Type de tête	Standard
Vente par quantité indivisible	1
Forme de la tête de l'unité de signalisation	Rond
Profil de l'unité de commande	Noir bouton-tournant à clé
Type de commande	Bouton maintenu
Positions de l'unité de commande	2 positions 90°
Type de verrouillage	Clé 421E
Position de retrait de la clé	À gauche

Complémentaires

Largeur hors tout CAO	29 mm
Hauteur hors tout CAO	29 mm
Profondeur hors tout CAO	72 mm
Poids du produit	0,098 kg
Tenue au nettoyage haute pression	7000000 Pa à 55 °C, distance : 0,1 m
Durée de vie mécanique	1000000 cycle
Code de composition électrique	C3 pour <6 contacts à l'aide desimple blocs dans montage avant C4 pour <6 contacts à l'aide desimple et double blocs dans montage avant C5 pour <5 contacts à l'aide desimple blocs dans montage avant C6 pour <5 contacts à l'aide desimple et double blocs dans montage avant C7 pour <4 contacts à l'aide desimple blocs dans montage avant C8 pour <4 contacts à l'aide desimple et double blocs dans montage avant C11 pour <3 contacts à l'aide desimple blocs dans montage avant C15 pour <1 contacts à l'aide desimple blocs dans montage avant
Présentation du produit	Élément de base

Environnement

Traitement de protection	TH
Température ambiante de stockage	-40...70 °C

Température ambiante de fonctionnement	-40...70 °C
Catégorie de surtension	Classe I conforming to CEI 60536
Degré de protection IP	IP66 se conformer à IEC 60529 IP67 IP69 IP69K
Tenue à l'environnement NEMA	NEMA 13 NEMA 4X
Normes	EN/CEI 60947-1 GB 14048.5 EN/CEI 60947-5-4 EN/CEI 60947-5-5 EN/CEI 60947-5-1 CSA C22.2 No 14 UL 508
Certifications du produit	CSA DNV BV LROS (Lloyds register of shipping) UL listed
Tenue aux vibrations	5 gn (f= 2...500 Hz) conforming to CEI 60068-2-6
Tenue aux chocs mécaniques	30 gn (durée = 18 ms) pour accélération d'une demi-onde sinusoïdale se conformer à CEI 60068-2-27 50 gn (durée = 11 ms) pour accélération d'une demi-onde sinusoïdale se conformer à CEI 60068-2-27

Emballage

Type d'emballage 1	PCE
Nb produits dans l'emballage 1	1
Hauteur de l'emballage 1	3,600 cm
Largeur de l'emballage 1	5,500 cm
Longueur de l'emballage 1	9,200 cm
Poids de l'emballage 1	105,000 g
Type d'emballage 2	S03
Nb produits dans l'emballage 2	100
Hauteur de l'emballage 2	30,000 cm
Largeur de l'emballage 2	30,000 cm
Longueur de l'emballage 2	40,000 cm
Poids de l'emballage 2	10,799 kg

Garantie contractuelle

Garantie	18 mois
-----------------	---------

Environmental Data

Schneider Electric vise à atteindre le statut de Net Zero d'ici 2050 grâce à des partenariats avec la chaîne logistique, des matériaux à faible impact et une circularité via notre campagne en cours "Use Better, Use Longer, Use Again" pour prolonger la durée de vie des produits et leur recyclabilité.

[Environmental Data expliquées >](#)

Empreinte environnementale

Empreinte carbone (kg CO2 eq.) 1

Profil environnemental [Profil environnemental du Produit](#)

Use Better

Matières et Substances

Emballage avec carton recyclé Non

Emballage sans plastique Non

[Directive UE RoHS](#)

Conformité proactive (produit hors de la portée juridique de la directive européenne RoHS)

Numéro SCIP F28cb399-1b6a-409d-ac7b-4169e47b25c8

Règlementation REACH [Déclaration REACH](#)

Use Again

Réemballer et réutiliser

Profil Économie Circulaire [Informations de fin de vie](#)

Reprise No

Dimensions Drawings

Dimensions

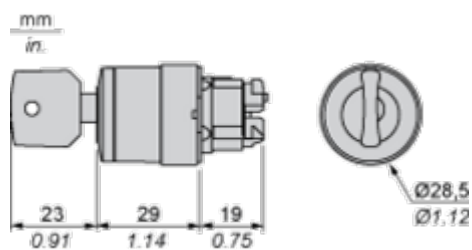

Mounting and Clearance

Panel Cut-out for Pushbuttons, Switches and Pilot Lights (Finished Holes, Ready for Installation)

Connection by Screw Clamp Terminals or Plug-in Connectors or on Printed Circuit Board	Connection by Faston Connectors
	
<p>(1) Diameter on finished panel or support</p> <p>(2) 40 mm min. / 1.57 in. min.</p> <p>(3) 30 mm min. / 1.18 in. min.</p> <p>(4) $\varnothing 22.5 \text{ mm} / 0.89 \text{ in.}$ recommended ($\varnothing 22.3 \text{ mm} \begin{smallmatrix} +0.4 \\ 0 \end{smallmatrix} / 0.88 \text{ in.} \begin{smallmatrix} +0.016 \\ 0 \end{smallmatrix}$)</p> <p>(5) 45 mm min. / 1.78 in. min.</p> <p>(6) 32 mm min. / 1.26 in. min.</p>	

Pushbuttons, Switches and Pilot Lights for Printed Circuit Board Connection

Panel Cut-outs (Viewed from Installer's Side)

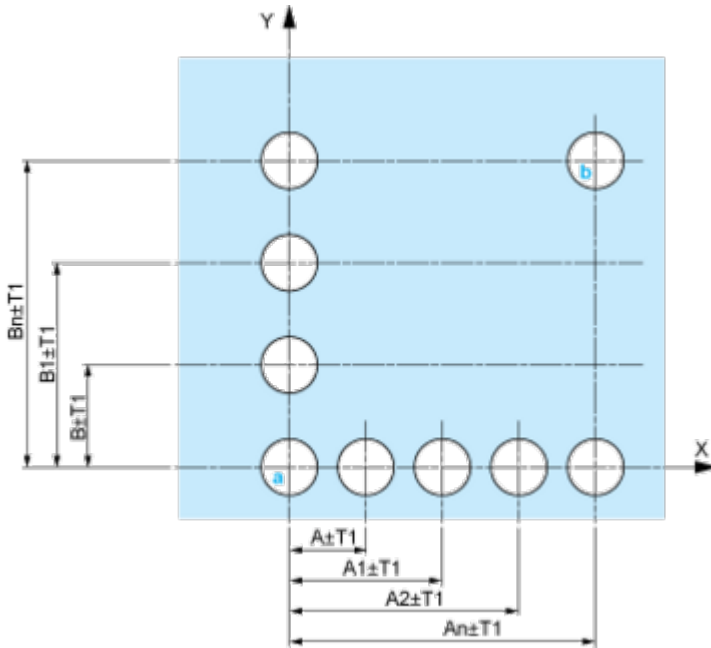

A: 30 mm min. / 1.18 in. min.

B: 40 mm min. / 1.57 in. min.

Printed Circuit Board Cut-outs (Viewed from Electrical Block Side)

Dimensions in mm

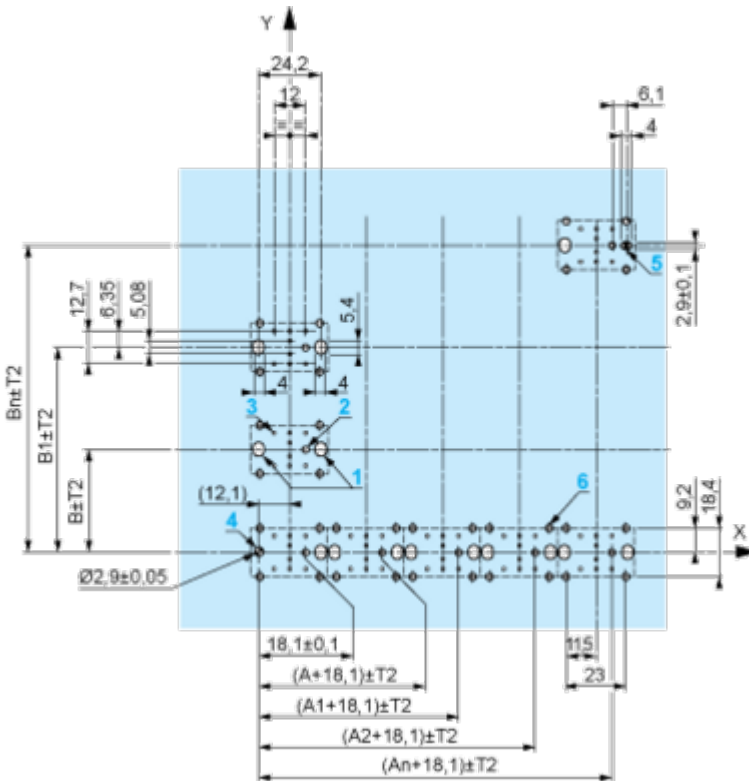

A: 30 mm min.

B: 40 mm min.

Dimensions in in.



A: 1.18 in. min.
 B: 1.57 in. min.

General Tolerances of the Panel and Printed Circuit Board

The cumulative tolerance must not exceed 0.3 mm / 0.012 in: T1 + T2 = 0.3 mm max.

Installation Precautions

- Minimum thickness of circuit board: 1.6 mm / 0.06 in.
- Cut-out diameter: 22.4 mm ± 0.1 / 0.88 in. ± 0.004
- Orientation of body/fixing collar ZB4 BZ009: ± 2° 30' (excluding cut-outs marked a and b).
- Tightening torque of screws ZBZ 006: 0.6 N.m (5.3 lbf.in) max.
- Allow for one ZB4 BZ079 fixing collar/pillar and its fixing screws:
 - every 90 mm / 3.54 in. horizontally (X), and 120 mm / 4.72 in. vertically (Y).
 - with each selector switch head (ZB4 BD*, ZB4 BJ*, ZB4 BG*).

The fixing centers marked a and b are diagonally opposed and must align with those marked 4 and 5.



(1) Panel

(2) Printed circuit board

Mounting of Adapter (Socket) ZBZ 01

- 1 2 elongated holes for ZBZ 006 screw access
- 2 1 hole $\varnothing 2.4 \text{ mm} \pm 0.05 / 0.09 \text{ in.} \pm 0.002$ for centring adapter ZBZ 01
- 3 $8 \times \varnothing 1.2 \text{ mm} / 0.05 \text{ in.}$ holes
- 4 1 hole $\varnothing 2.9 \text{ mm} \pm 0.05 / 0.11 \text{ in.} \pm 0.002$, for aligning the printed circuit board (with cut-out marked a)
- 5 1 elongated hole for aligning the printed circuit board (with cut-out marked b)
- 6 4 holes $\varnothing 2.4 \text{ mm} / 0.09 \text{ in.}$ for clipping in adapter ZBZ 01

Dimensions An + 18.1 relate to the $\varnothing 2.4 \text{ mm} \pm 0.05 / 0.09 \text{ in.} \pm 0.002$ holes for centring adapter ZBZ 01.

Technical Description

Electrical Composition Corresponding to Code C3



Electrical Composition Corresponding to Code C4



Electrical Composition Corresponding to Code C5



Electrical Composition Corresponding to Code C6



Electrical Composition Corresponding to Code C7



Electrical Composition Corresponding to Code C8

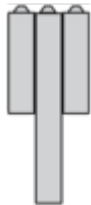

Electrical Composition Corresponding to Codes C9, C11, SF1 and SR1



Electrical Composition Corresponding to Code C15

1 N/O



1 N/C



1 N/O + N/C or 1 N/O + N/O or 1 N/C + N/C



Legend

Single contact



Double contact



Light block







Possible location



Sequence of Contacts Fitted to 2-position Selector Switch Body

Position 315°



Push	Position	Top			
		Bottom			
	Location		Left	Centre	Right
	State		0	0	0
	Contacts		N/O	open	open
		N/C	closed	closed	closed

Position 45°



Push	Position	Top			
		Bottom			
	Location		Left	Centre	Right
	State		1	1	1
	Contacts		N/O	closed	closed
		N/C	open	open	open

Technical Illustration

Dimensions

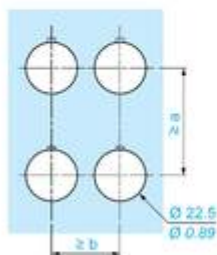
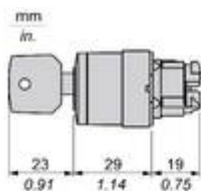

		a (mm)	a (in.)	b (mm)	b (in.)
		40	1.57	30	1.18
ZBE.....	ZBV.....				
		45	1.77	32	1.26
ZBE.....3	ZBV.....3				
		40	1.57	30	1.18
ZBE.....4	ZBV.....4				
		50	1.97	30	1.18
ZBE.....5	ZBV.....5				
		40	1.57	30	1.18
ZBE.....9	ZBV.....9				
		40	1.57	30	1.18
ZBRT•	ZBRV1				

Offer Marketing Illustration

Product benefits / Features

Technical Benefits

Harmony XB4

Conformity with IEC, UL, CSA, CCC EAC, and JIS standards, as well as CE marking and marine approvals

Up to IP66, 67, 69, 69K, and type 4X protection ratings

High vibration resistance with shake-proof terminal screws



Operating temperature from -40°C to 70°C

Shock protection level up to IK06

Secure switching of inductive or heavy DC loads directly – 100 000 operations at 10A, 24V dc

Offer Marketing Illustration

Product benefits / Features

Features
Harmony XB4

- Quick and easy assembly and disassembly
- Excellent mechanical connection with operator head
- Various types of connection: screw clamp, connector, Faston connector, spring terminal, or printed circuit board
- Large set of accessories to customize your panels
- Robustness to withstand harsh environments

Image of product / Alternate images

Alternative

